

||| Maintaining Your Keyboard

Like all electronic equipment you need to avoid getting it wet, dropping it, or using undue force to depress the keys or operate the latch handle.

Do not subject the keyboard to extremes in temperature. Your keyboard will operate best in temperatures of - 5° C to 50° C (23°F to 122°F). Keep the surface of your keyboard clean by wiping with a soft cloth that is dampened with a mild cleaning solutions; preferably water and mild soap.

Important: Do not attempt to adjust the keyboard without releasing the latch handle and **DO NOT PLACE ANY LUBRICATION or CLEANING FLUID IN THE BALL JOINT. THIS WILL VOID YOUR WARRANTY.**

||| Device Support

As mobile devices continue to expand in the marketplace, the Goldtouch Go!² will endeavor to support all possible devices through compliance with hardware standards.

To obtain support, download guides, and to learn about additional ergonomic and mobile ergonomic products from goldtouch, please visit our website at:

www.goldtouch.com.

Windows XP SP2+
Windows Vista
Windows 7
Windows 8

Mac OS X 10.4+

Goldtouch
www.goldtouch.com



Goldtouch Go!² Travel Keyboard

||| GTP-0044 GOLDTOUCH Go!² MOBILE USB KEYBOARD



User Manual

Congratulations on your purchase of a Goldtouch Go!² Mobile Keyboard.

You're about to join the tens of thousands of people who've traded in their OEM keyboards for the most innovative, comfortable ergonomic keyboards ever designed.

The technology behind the Goldtouch ergonomic keyboard is one that recognizes the unique needs of every individual, which vary according to body type, height, weight, shoulder width, hand position, and other health and lifestyle factors. Goldtouch believes that ergonomic keyboards should fit the individual, not force the individual to conform to the keyboard.

Utilizing our patented ball and lever locking mechanism, our new Goldtouch Go!² Mobile Keyboard offers you personalized adjustments for customized comfort that can significantly improve personal productivity and mitigate the risks associated with computer-related repetitive strain injuries.

From the quality of our components to driver-free setup; every Goldtouch keyboard is designed for business. Our Go!² Mobile Keyboard is light and compact for easy storage, and features universal PC and MAC compatibility. Every Goldtouch keyboard is created to enhance your personal productivity and deliver a speedy return on investment.

We thank you for your purchase and wish you years of personal comfort and productivity.

© 2013 Key Ovation, LLC. All rights reserved. Goldtouch, the Goldtouch logo and Productivity through Prevention® are registered trademarks of Key Ovation, LLC. All other trademarks are copyright their respective owners. All rights reserved.



Getting Started - Initial Keyboard Setup

The Goldtouch Go!² Mobile Keyboard is Plug-and-Play for both Windows® and Mac OS®. The keyboard doesn't require any additional drivers for installation.

Setting up your new keyboard is easy:

1. Select your operating system, by adjusting the switch located on the back of the keyboard to either PC or Mac mode. (Please note, keyboards are in PC mode by default).
2. Plug the Goldtouch Go!² Mobile Keyboard's USB male connector into a free USB port on your desktop or laptop computer.
3. Please allow sufficient time for Windows or Mac OS to automatically recognize the keyboard and install the proper drivers.
4. When the system level drivers are installed and Windows or MAC OS setup is completed, begin working.





FN - Function Features

To activate the FN (Function) features on your Goldtouch Go!² keyboard, press the FN key. The blue FN indicator light will appear in the status bar on the right hand corner of your keyboard when the FN function is turned on. When FN is turned on, you're now free to utilize the following Function Features, outlined in blue (for PC) and yellow (for Mac), without having to hold down the FN key:

Windows & Mac FN Features

-  Play/Pause
-  Rewind
-  Fast Forward
-  Mute
-  Volume Down
-  Volume Up

Windows Only FN Features

-  Email
-  Calculator
-  Home Screen
-  Favorites Folder
-  My Computer

FN - Embedded Numeric Keypad Feature

To activate the Go!² keyboards embedded numeric keypad:

1. Press the FN button, to turn the FN Feature on the keyboard on. The blue FN indicator light will appear in the status bar on the right hand corner of your keyboard when the FN function is turned on.

Step Two, go Vertical!

Your next adjustment is to correct the inward turn of your wrists or pronation.



1. First, let's find your tent angle. Start by grasping a pen in your hand with your palm facing down.
2. Now, relax and rotate your arm (clockwise if the pen is in your right hand, counter-clockwise if you are left handed) until you feel a release in pressure — this angle is usually between 7 and 15 degrees. Congratulations. You've found your tenting angle.
3. Release the latch on the top of the keyboard.
4. Lift the segments by grasping the segments near the center – close to the ball and replicate the angle you found earlier. Don't forget to keep your split angle as part of this final adjustment. Once you've made this final adjustment, lock to the lever back into position. You may find that over a period of time, these two angles may change. Feel free to continue adjusting the keyboard to dial-in your own personal split and tent angle for greatest comfort.

NOTE: always ensure that your fingers or other foreign objects are not in between the keyboard and the locking handle when closing the lever. It's important NOT to over-adjust the keyboard. See our website www.goldtouch.com for a video demonstration on how to properly adjust your Goldtouch keyboard.

Warning

Please be aware that there are two magnetized rubber bumpers located on the right and left sides of your keyboard. These magnetic bumpers help ensure that the two segments of the keyboard stay folded during transport.

We recommend that you avoid directly exposing your credit or debit cards to these magnetic strips. Credit cards may become unreadable when exposed to magnets for long periods of time. Close proximity will not have an effect on the credit card. The card would need to be placed directly on the strip for some period to cause an issue.

Help and Service Information

You may need only simple instructions to correct a problem with your purchase from Goldtouch, Key Ovation. You can email our Support team at support@goldtouch.com. Hours of operation are from 9am-5pm CST, Monday through Friday (times subject to change). 24 hour service is available through our website FAQ's at www.goldtouch.com.

How to change between Mac and PC mode

To choose between Mac and PC mode, please use the switch on the back of the keyboard to select your operating system. Please note, keyboards are in PC mode by default.

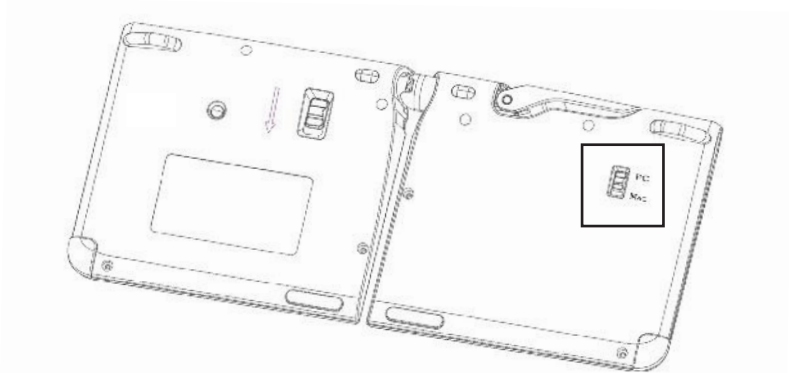

How to adjust the Goldtouch Go!2

Step One, dialing in personalized comfort.

A leading contributing factor to the development of computer-related repetitive strain injuries is the flat standard keyboard, which places the forearm and wrist in awkward positions for long periods of time.



1. Your first adjustment of your new Goldtouch Go!2 Mobile Keyboard is to adjust the keyboard to straighten your wrists and forearm along the horizontal plane. Start by releasing the latch on the top of the keyboard.
2. Now, move the segments until the angle of each panel matches the natural line created by your fingers across the center row of keys when both your wrists and forearms are straight.
3. This first individual adjustment will correct for undue pressure caused in the wrist and forearm when typing on a normal keyboard.
4. When you've established the correct angle, lock the lever down.

NOTE: Goldtouch recommends you work in this position for a few days until you're comfortable with the split of the panels, compared to your previous keyboard.

FN - Embedded Numeric Keypad Feature

2. Press the Num Lock key in the upper right hand corner of the keyboard. The blue FN indicator light on the keyboard status bar will turn white when Num Lock and FN are engaged. (Please note, for Num Lock to work, it has to be used in conjunction with the FN key.)
3. The embedded numeric keypad on the right side of your keyboard is now engaged.

NOTE: To turn off the Num Lock and FN features, simply press the Num Lock and FN keys to deactivate. The corresponding indicator lights on the status bar will turn off when these functions are deactivated. When Num Lock is turned on, you can easily toggle between regular keyboard mode and the embedded numeric keypad by turning Function (FN) off and on.

Keyboard Status Bar

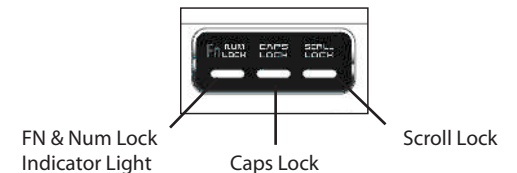

FN Indicator Light Guide:

Blue Light- FN Feature is Engaged

White Light- FN Feature and Num Lock are Engaged
(Embedded Numeric Keypad is working)

Orange Light- Num Lock Feature is Engaged, but FN Function is off.
(Embedded Numeric Keypad will not work. In order for the Num Lock feature to work it must be used in conjunction with the FN feature. The status bar light will appear white when both features are engaged.)

Go!2 Keyboard Layout

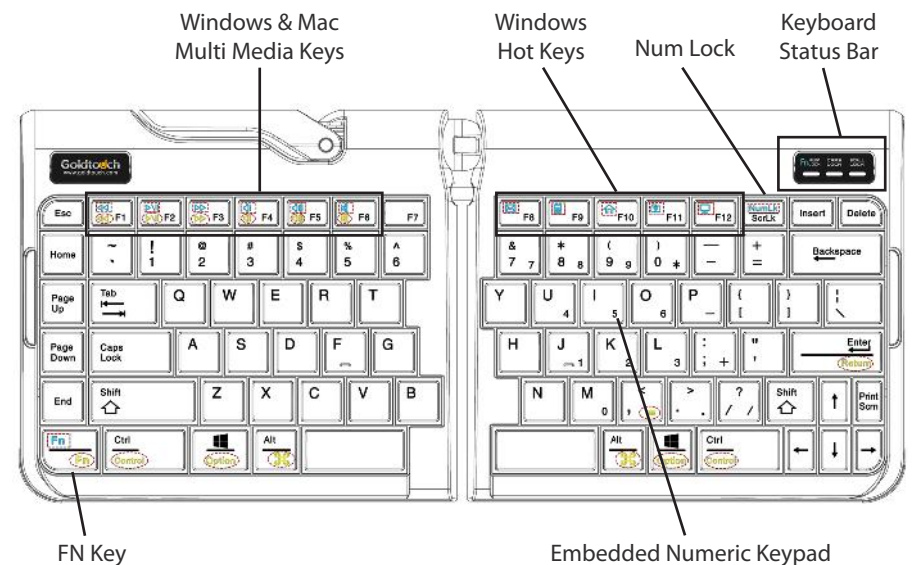

How to Fold Your Keyboard

1. Push and hold the Lock button on the back of the Keyboard to the Unlock position, and gently pull the two halves of the keyboard apart.

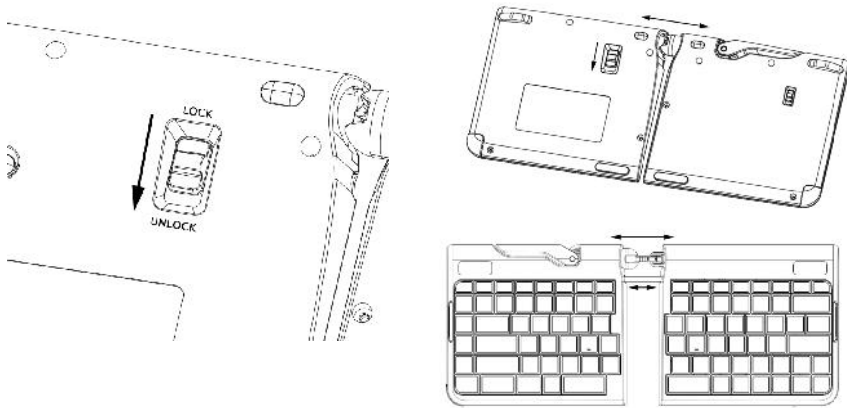

2. Once the two keyboard halves have been separated, release the handle on the top of the keyboard.

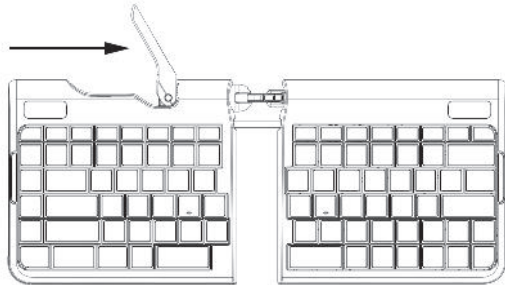

3. Next, fold the two keyboard segments together.

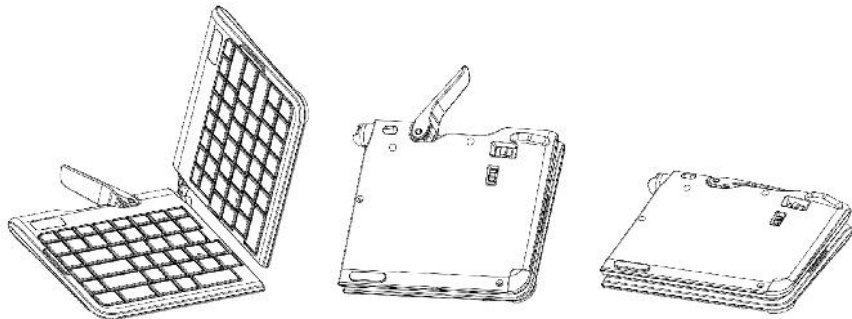

4. Push the handle on the top of the keyboard, back into the closed and locked position.

How to Unfold Your Keyboard

1. Undo the handle lever on the top of your keyboard, and unfold the two segments of the keyboard.

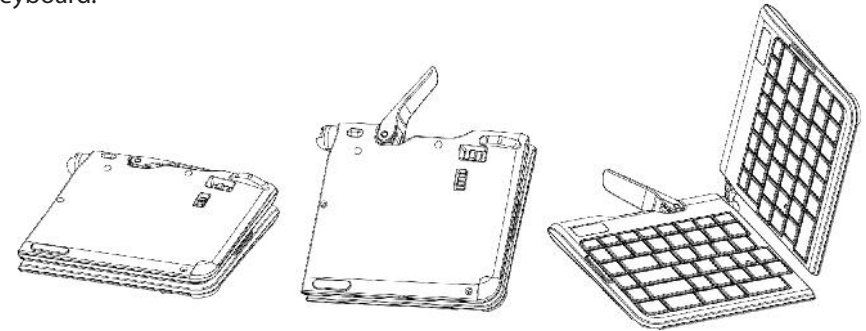

2. When the keyboard is unfolded, push the handle lever on the top of your keyboard back into the closed and locked position.

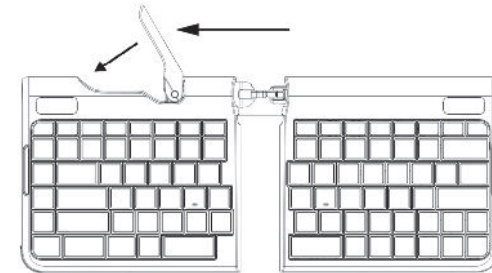

3. Next, you're going to push the two keyboard segments into the closed and locked position. To do this, push and hold the Lock button on the back of the keyboard to the Unlocked position, now push the two segments of the keyboard together until you can no longer see the folding hinge.

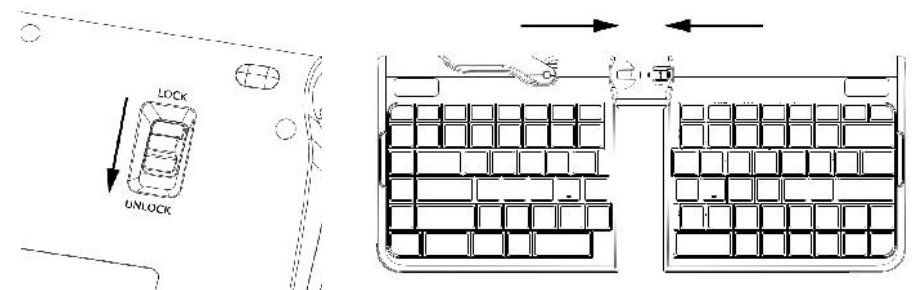

4. Make your keyboard comfort adjustment and begin working.